

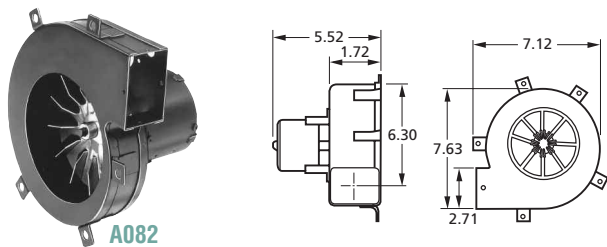

Centrifugal Blowers

MARS SERIES **079**

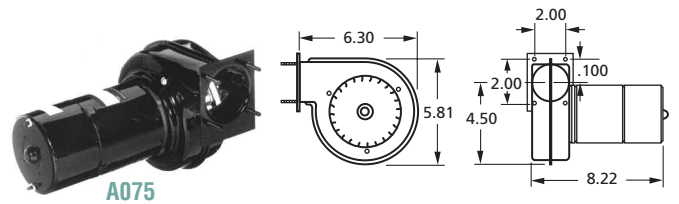
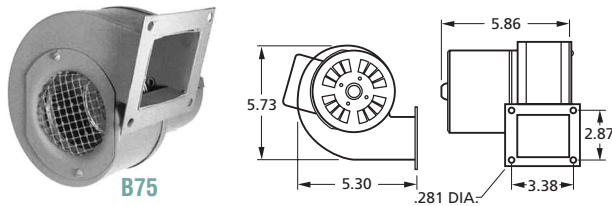
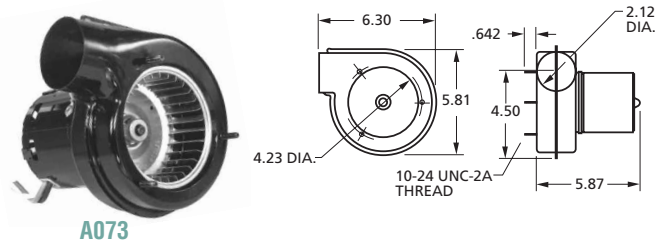
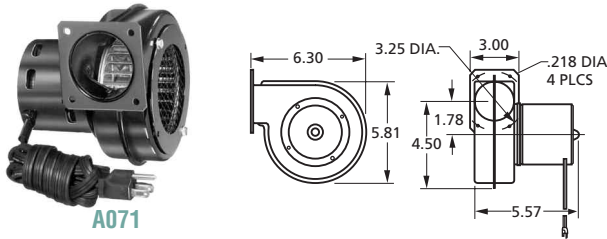
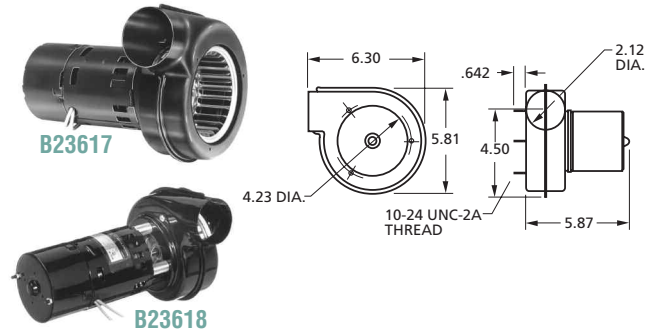
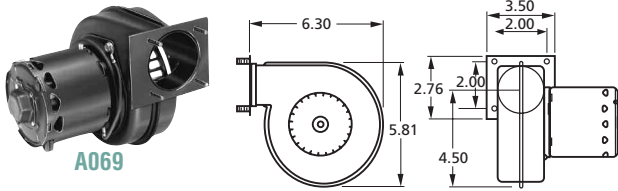

MODEL#	CFM AT STATIC PRESSURE SHOWN STATIC PRESSURE (INCHES OF WATER)										NAMEPLATE CFM	VOLTS	FREQ.	NO. OF SPEEDS	RPM@ FREE AIR	AMPS@ FREE AIR	BRNG
	0.1	0.2	0.3	0.4	0.5	0.6	0.7	0.8	0.9	1							
A069	72	67	63	60	53	52	50	43	40	—	69	208-230	60	1	3000	.45	SLV
B23617	72	67	64	62	57	55	50	46	41	33	70	115/230	60	1	3000	.9/45	SLV
B23618	72	67	64	62	57	55	50	46	41	33	70	115/208-230	60	1	3000	.95/45	BALL
A071	70	67	63	58	57	55	51	35	—	—	71	115	60	1	2850	.7	SLV
A073	72	69	67	63	61	57	53	48	43	37	73	115/230	50/60	1	3200	.7/35	BALL
B75	68	63	57	47	34	14	—	—	—	—	75	115	60	1	3200	.59	SLV
A075	73	69	65	62	58	55	50	45	40	35	75	230	60	1	3200	.4	BALL
A082	66	62	53	52	47	42	23	—	—	—	75	115	60	1	2800	.95	SLV

FASCO

